

**BILL OF MATERIALS**

QTY.	DESCRIPTION	CODE
1	10'-0" PLAIN PANEL	CPN-S120
1	10'-0" HAYWARD SKIMMER	CPN-S120SH
3	8'-0" PLAIN PANEL	CPN-S096
1	8'-0" HAYWARD RETURN	CPN-S096RH
4	6'-0" PLAIN PANEL	CPN-S072
1	6'-0" HAYWARD RETURN	CPN-S072RH
1	1' X 1' REVERSE CORNER PANEL	CPN-CR012012
15	BUTTRESS	CPC-BUT
21	BUTTRESS HARDWARE	CPC-HDW-1234L
1	TENSION STRAP	CPC-TENSTRP
1	LEFT ANGLE BUTTRESS	CPC-BUTANKDL
1	RIGHT ANGLE BUTTRESS	CPC-BUTANKDR
1	TENSION STRAP HARDWARE	CPC-HDWTENSTRP
9	45° ANGLE BRACE, 12GA	CPC-AB45
1	45° BENT HARDWARE (72)	CPC-HDW-PK45
1	45° MAKE UP HARDWARE (15)	CPC-HDW-PK45M
2	STRAIGHT HARDWARE (30)	IPC-HDWSTRT30
2	STRAIGHT HARDWARE (40)	IPC-HDWSTRT40

# 20 X 30 KIDNEY LEFT



BUTTRESS LOCATIONS

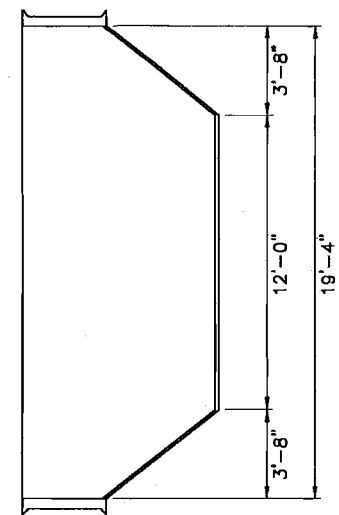
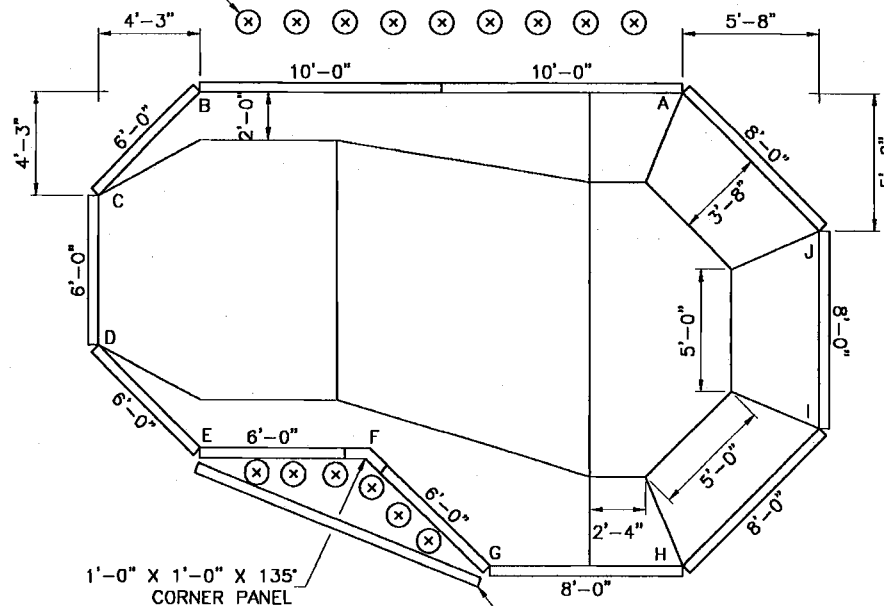

1'-0" X 1'-0" X 135°  
CORNER PANEL

SEE STRAPPING DETAIL  
ON FOLLOWING PAGES.

A to C	24'-7"	B to D	11'-1"
A to D	26'-4"	B to E	14'-6"
A to E	24'-8"	B to F	16'-1"
A to F	19'-6"	B to G	22'-9"
A to G	20'-11"	B to H	27'-10"
A to H	19'-4"	B to I	29'-1"
A to I	14'-9"	B to J	26'-3"

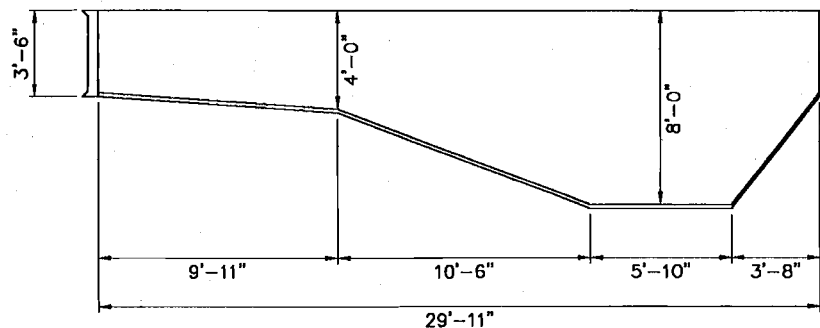

**WARNING:**

JUMPING OR DIVING IN ON-GROUND POOLS CAN CAUSE PERMANENT INJURY OR DEATH.

**NOTE:**

EXPANDABLE BOTTOMS ARE BOWLED OR DISHED; THE MEASUREMENTS SUPPLIED ARE GUIDES RATHER THAN EXACT MEASUREMENTS.

**REVISIONS**

CHG.	DATE	BY

CHAMPLAIN STEEL

FULL 8'-0" HOPPER

VOLUME: 14089 IMP GAL

DATE: JAN 01, 2002

AREA: 461.1 SQ. FT.

O\N: KD2030LS\_02

PERIMETER: 84'-0"

SCALE: 1/8" = 1'-0"

# OPTIONAL BOTTOM CONFIGURATIONS

20 X 30 KIDNEY LEFT

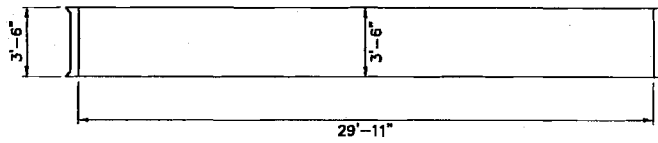
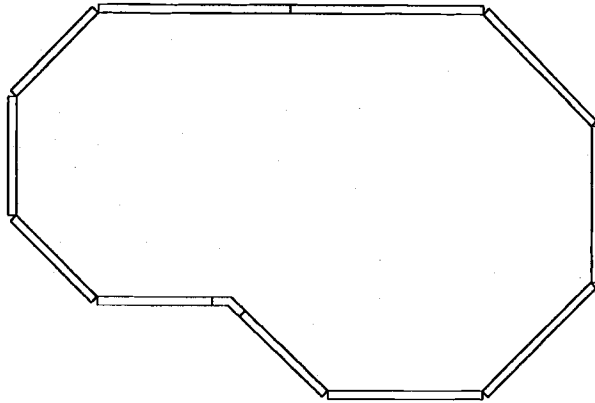

FLAT BOTTOM  
VOLUME: 8138 IMP GAL

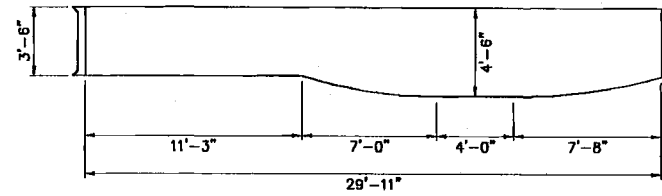
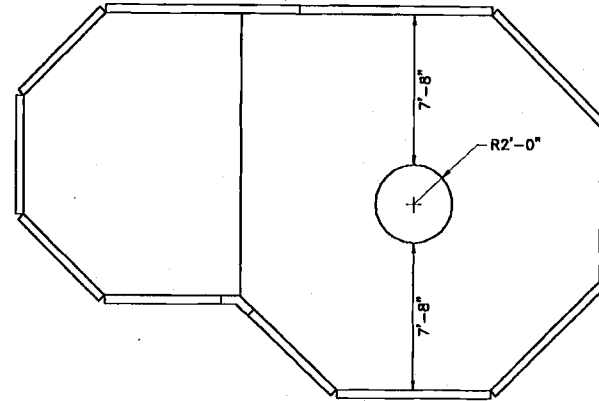

PARTIAL 5' EXPANDABLE BOTTOM  
VOLUME: 8985 IMP GAL

# KIDNEY/KIDNEY REVERSE STRAPPING DETAILS

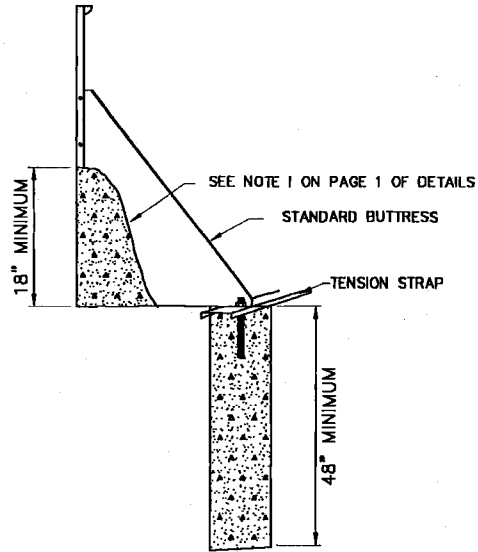

**VIEW ON "A-A"**

## TENSION STRAP CONNECTION

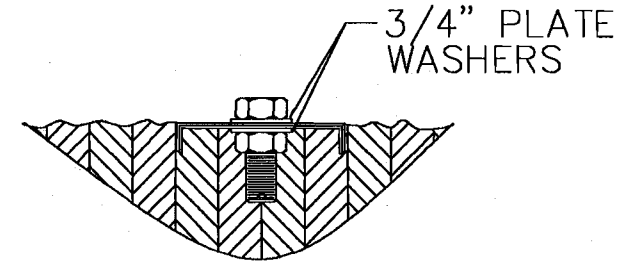

**VIEW ON "B-B"**

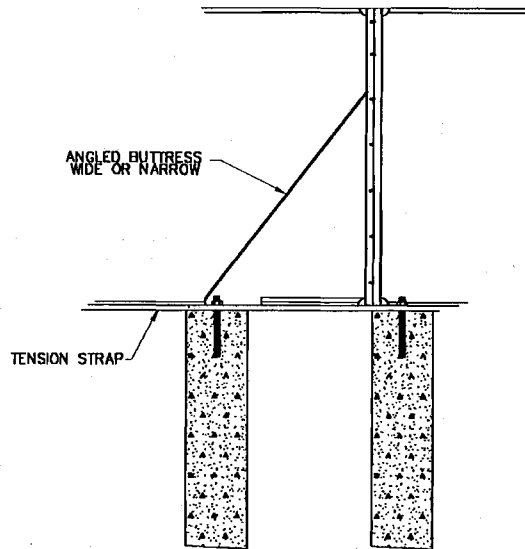

**VIEW ON "C-C"**

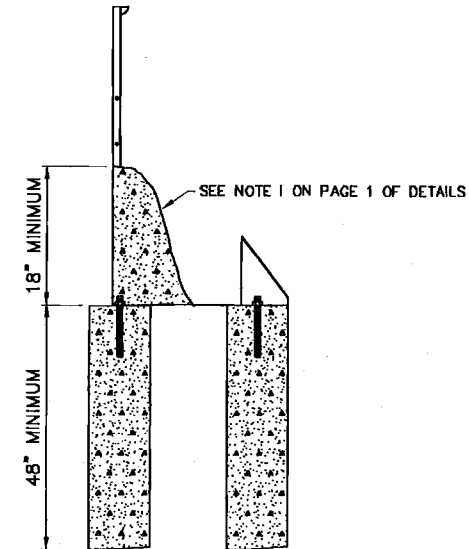

**VIEW ON "D-D"**

# 20 X 30 KIDNEY/KIDNEY REVERSE STRAPPING DETAILS

