

BILL OF MATERIALS

QTY.	DESCRIPTION	CODE
1	10'-0" PLAIN PANEL	CPN-S120
1	10'-0" HAYWARD SKIMMER	CPN-S120SH
3	8'-0" PLAIN PANEL	CPN-S096
1	8'-0" HAYWARD RETURN	CPN-S096RH
4	6'-0" PLAIN PANEL	CPN-S072
1	6'-0" HAYWARD RETURN	CPN-S072RH
1	1' X 1' REVERSE CORNER PANEL	CPN-CR012012
15	BUTTRESS	CPC-BUT
21	BUTTRESS HARDWARE	CPC-HDW-1234L
1	TENSION STRAP	CPC-TENSTRP
1	LEFT ANGLE BUTTRESS	CPC-BUTANKDL
1	RIGHT ANGLE BUTTRESS	CPC-BUTANKDR
1	TENSION STRAP HARDWARE	CPC-HDWTENSTRP
9	45° ANGLE BRACE, 12GA	CPC-AB45
1	45° BENT HARDWARE (72)	CPC-HDW-PK45
1	45° MAKE UP HARDWARE (15)	CPC-HDW-PK45M
2	STRAIGHT HARDWARE (30)	IPC-HDWSTRT30
2	STRAIGHT HARDWARE (40)	IPC-HDWSTRT40

20 X 30 KIDNEY REVERSE RIGHT

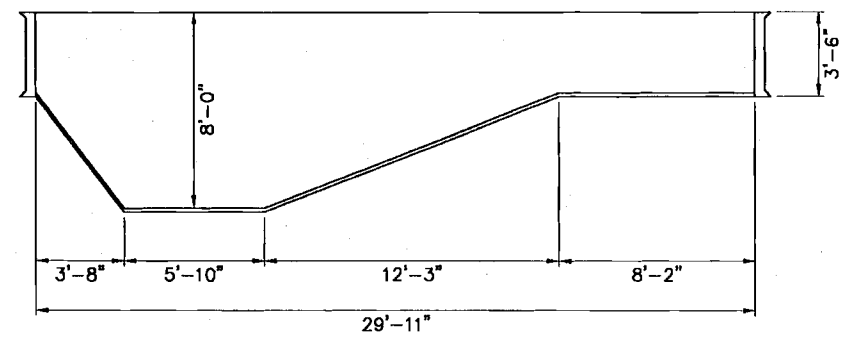
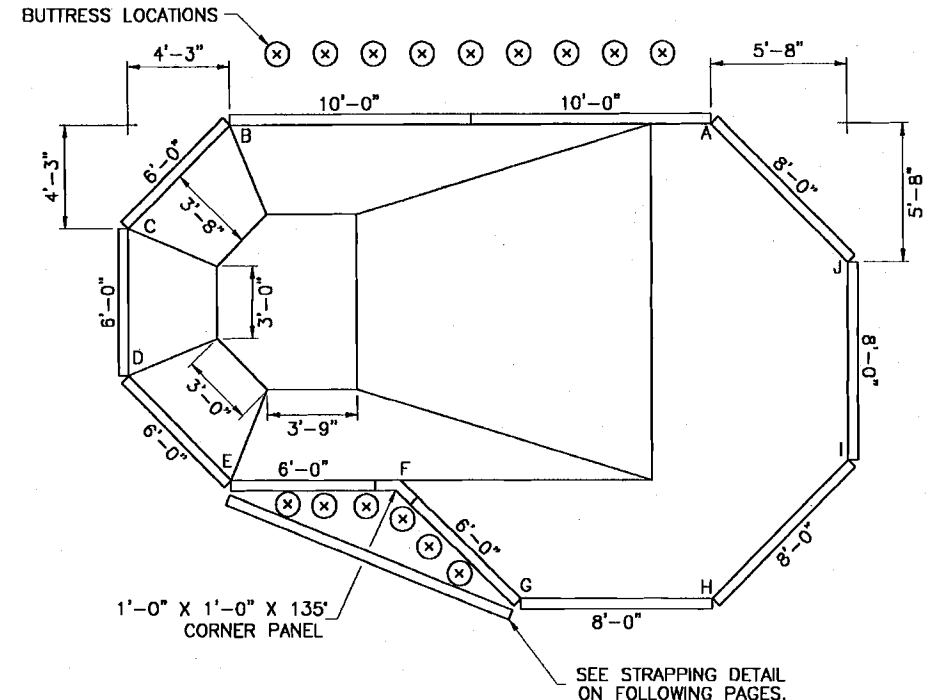
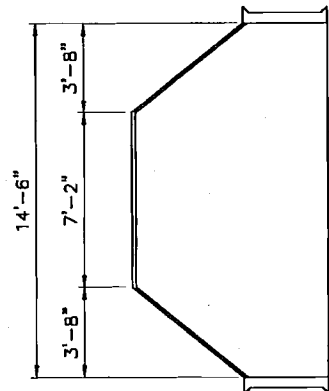

A to C	24'-7"	B to D	11'-1"
A to D	26'-4"	B to E	14'-6"
A to E	24'-8"	B to F	16'-1"
A to F	19'-6"	B to G	22'-9"
A to G	20'-11"	B to H	27'-10"
A to H	19'-4"	B to I	29'-1"
A to I	14'-9"	B to J	26'-3"

WARNING:
 JUMPING OR DIVING IN ON-GROUND POOLS CAN CAUSE PERMANENT INJURY OR DEATH.

NOTE:
 EXPANDABLE BOTTOMS ARE BOWLED OR DISHED; THE MEASUREMENTS SUPPLIED ARE GUIDES RATHER THAN EXACT MEASUREMENTS.

REVISIONS			CHAMPLAIN STEEL
CHG.	DATE	BY	
			FULL 8'-0" HOPPER
VOLUME: 12537 IMP GAL			DATE: JAN 01, 2002
AREA: 461.1 SQ. FT.			O\N: KR2030RS_02
PERIMETER: 84'-0"			SCALE: 1/8" = 1'-0"

OPTIONAL BOTTOM CONFIGURATIONS

20 X 30 KIDNEY REVERSE RIGHT

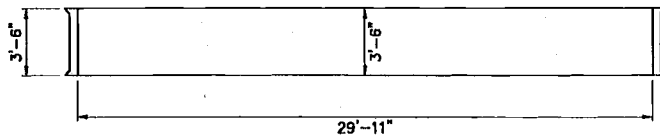
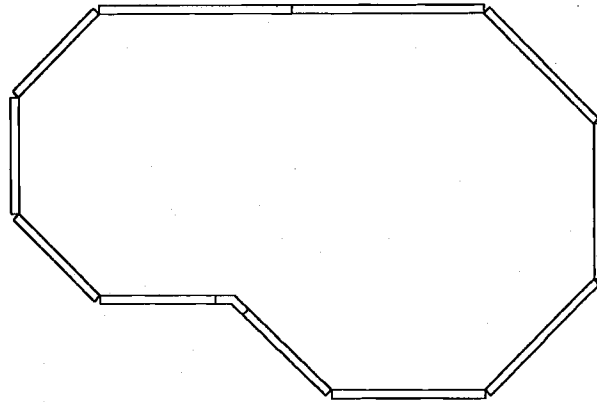

FLAT BOTTOM
VOLUME: 8138 IMP GAL

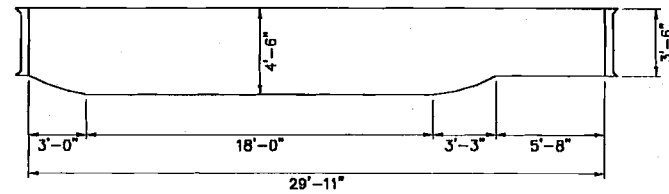
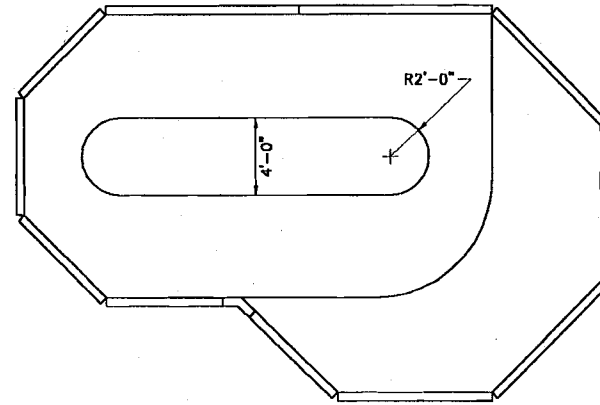

FULL 5' EXPANDABLE BOTTOM
VOLUME: 10782 IMP GAL

KIDNEY/KIDNEY REVERSE STRAPPING DETAILS

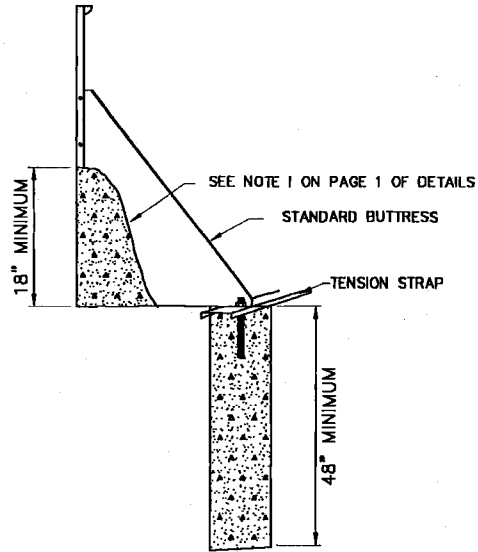

VIEW ON "A-A"

TENSION STRAP CONNECTION

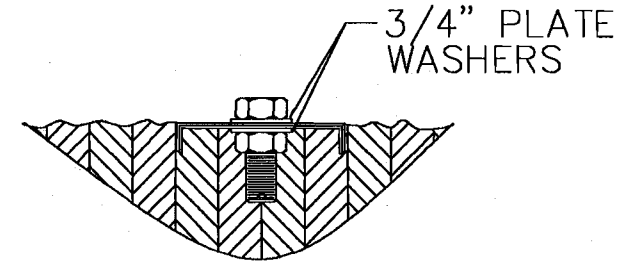

VIEW ON "B-B"

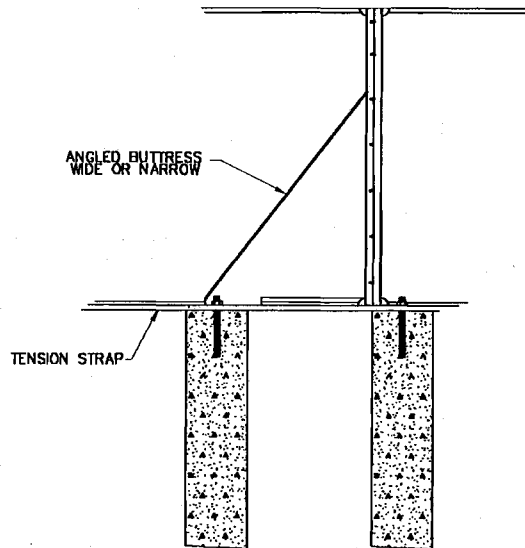

VIEW ON "C-C"

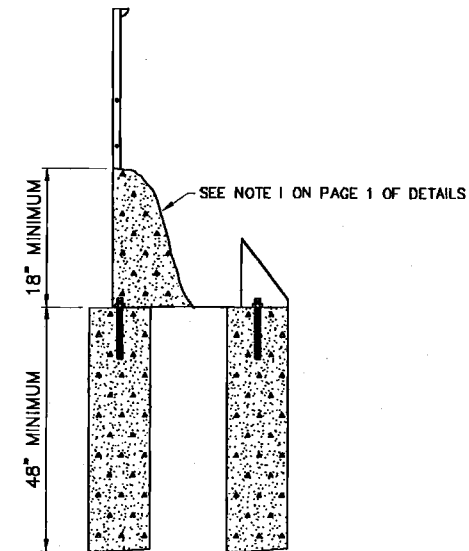

VIEW ON "D-D"

20 X 30 KIDNEY/KIDNEY REVERSE STRAPPING DETAILS

