

FirePit®

Portable Outdoor Fireplace

Whalen

Assembly Instructions / Owner's Manual
for

Model No. **41210** (28" Black) / **41211** (28" Green)

FOR CUSTOMER SERVICE

OR

ASSEMBLY ASSISTANCE

1-800-225-1438 / info@whalenco.com

www.whalenco.com

Please Do Not Return To Retail Store!

!WARNING!

FIREPIT® IS FOR OUTDOOR USE ONLY!

DO NOT USE FIREPIT® INDOORS!

INDOOR USE CAN BE FATAL!

Packed by-



WHALEN LIMITED WARRANTY

Whalen Mfg. Co., (Whalen) hereby warrants to the ORIGINAL RETAIL PURCHASER of this product that if it is assembled and operated in accordance with Whalen's printed instructions accompanying it, then for a period of five (5) years from the date of purchase all parts of the Whalen FirePit, excluding the screen unit, shall be free from defects in material and workmanship.

Whalen shall not be liable under this or any implied warranty for incidental or consequential damages. This warranty gives you specific legal rights, and you may have other rights which vary from state to state. This warranty is applicable in the USA and Canada. Whalen requires reasonable proof of your date of purchase.

THEREFORE, YOU SHOULD RETAIN YOUR SALES SLIP OR INVOICE.

This Limited Warranty shall be limited to the repair or replacement of parts which prove defective under normal use and service and which on examination shall indicate, to Whalen's satisfaction, they are defective. Any part that is claimed to be defective and covered by this Limited Warranty must be returned with transportation costs prepaid to

Whalen Mfg. Co., Customer Service Center, 1270 E Murray St, Macomb, IL 61455.

If Whalen's inspection confirms the defect and the claim, Whalen will elect to repair or replace such part without charge and return it to you freight or postage prepaid.

Note: All Whalen Mfg. Co products are subject to change, upgrade and improvement without notification.

Exploded Parts Diagram

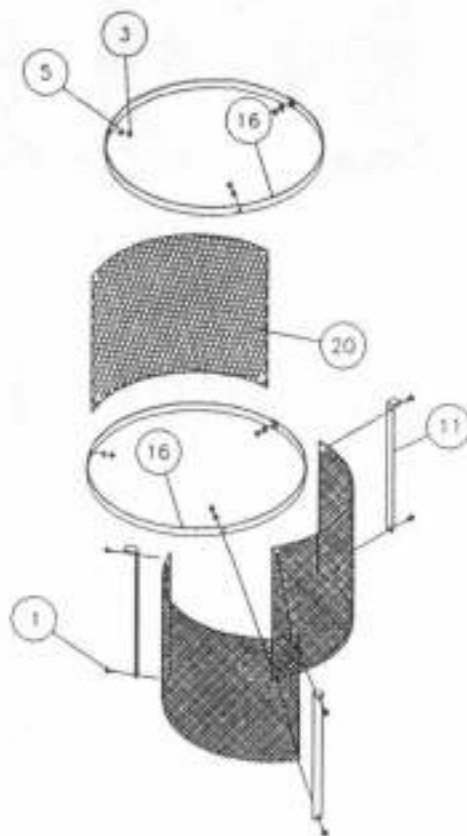
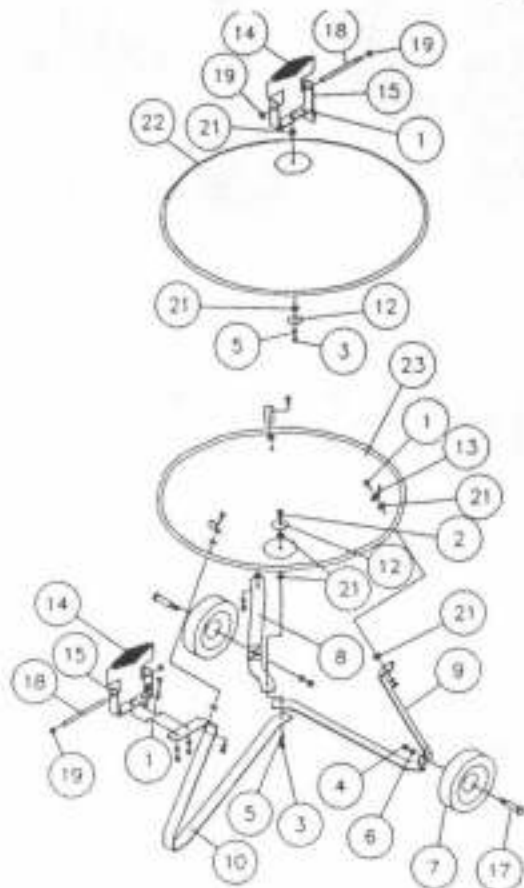

PARTS LIST FOR 28" FirePit, 18" SCREENS

Ref.No.	Part No.	Part Description	Quantity
1	2503-102	5/16-18 x 1 Truss Head Bolt	12
2	2503-105	5/16-18 x 1-1/4 Truss Hd Bolt	1
3	2520-201	5/16-18 Hex Nut	13
4	2520-251	3/8-18 Hex Nut	2
5	2525-201	5/16 Mod Lockwashers	13
6	2525-251	3/8 Mod Lockwashers	2
7	40167	7" OD Plastic Wheel	2
8	40389	Wheel Leg, RH, 28" FirePit	1
9	40390	Wheel Leg, LH, 28" FirePit	1
10	40306	Stationary Leg, 28" FirePit	1
11	40310	18" Screen Upright	3
12	40308	5/16 x 1-1/2 Fender Washer	2
13	40311	Ring Clip, FirePit	3
14	40314	1-1/2 x 4-1/2 Stove Handle	2

PARTS LIST FOR 28" FirePit, 18" SCREENS

Ref.No.	Part No.	Part Description	Quantity
15	40317	Handle, FirePit	2
16	40309	Screen Rings, FirePit	2
17	40325	1/2 x 1-1/2 Axle Bolt	2
18	40348	Handle Rod, FirePit	2
19	40349	Push Nut	4
20	40488	18" Screen, 28" FirePit	3
21	40389	Fiber Washer	10
22	40337	Porcelain Black, 28" Top (model 41210)	
23	40338	Porcelain Black, 28" Bot (model 41210)	
22	40375	Porcelain Green, 28" Top (model 41211)	
23	40376	Porcelain Green, 28" Bot (model 41211)	

TOOLS REQUIRED FOR ASSEMBLY

(1) Straight Bit Screwdriver & (2) Adjustable End Wrenches

OR

Screwdriver and 1 each 1/2", 9/16" and 3/4" Open or Box End Wrenches

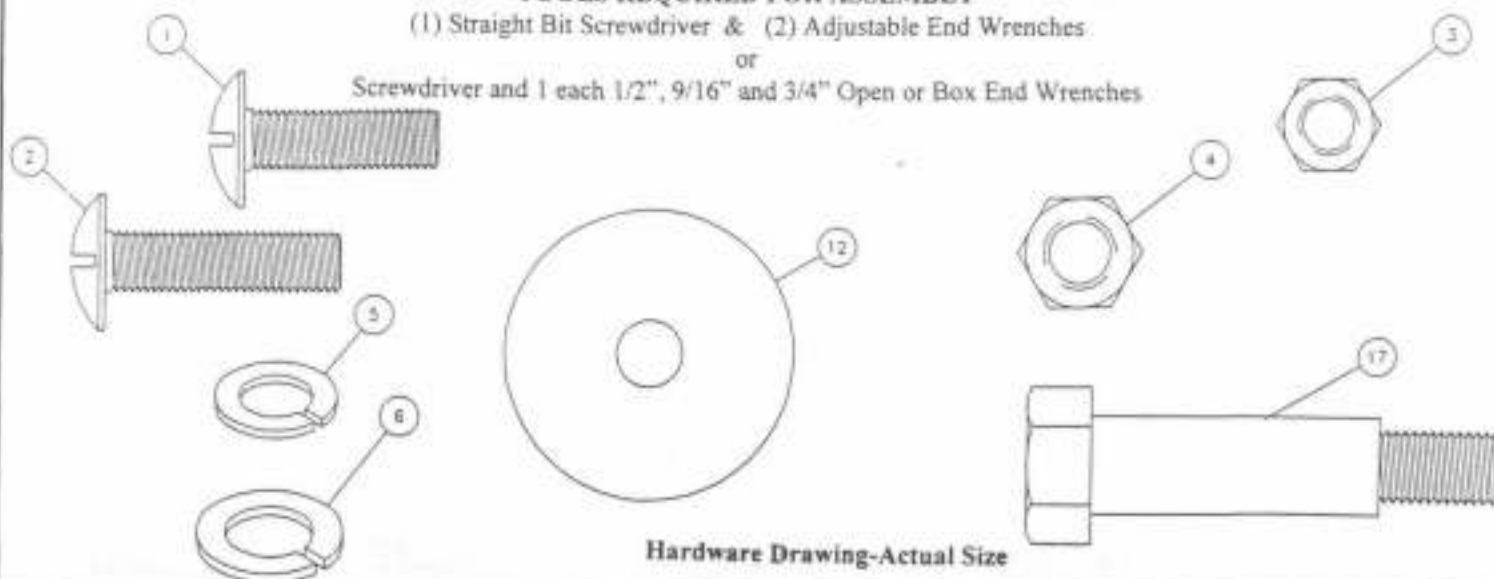

Hardware Drawing-Actual Size

ASSEMBLY INSTRUCTIONS

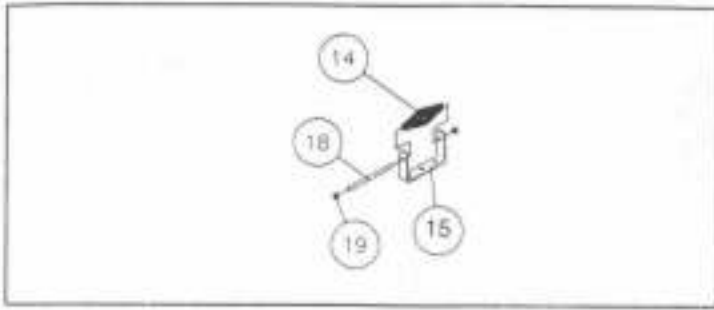

Step 1- Assemble FirePit Handles- Assemble stove handle(14) to FirePit handle(15) using push nut(19) on either end of handle rod(18). Repeat for all handles.

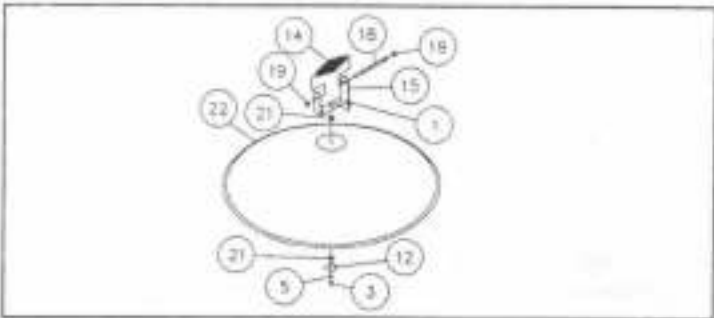

Step 2- Assemble to FirePit Top- Assemble handle(15) to center hole of FirePit top(22) by inserting 5/16 bolt(1) through handle followed by one 5/16 fiber washer(21) on each side of center hole in top(22), 5/16 fender washer(12), 5/16 lock washer(5) and 5/16 hex nut(3). Finish tighten. Do not over tighten! Over-tightening may fracture porcelain. **IMPORTANT!** Only fiber washers(21) should contact porcelain!

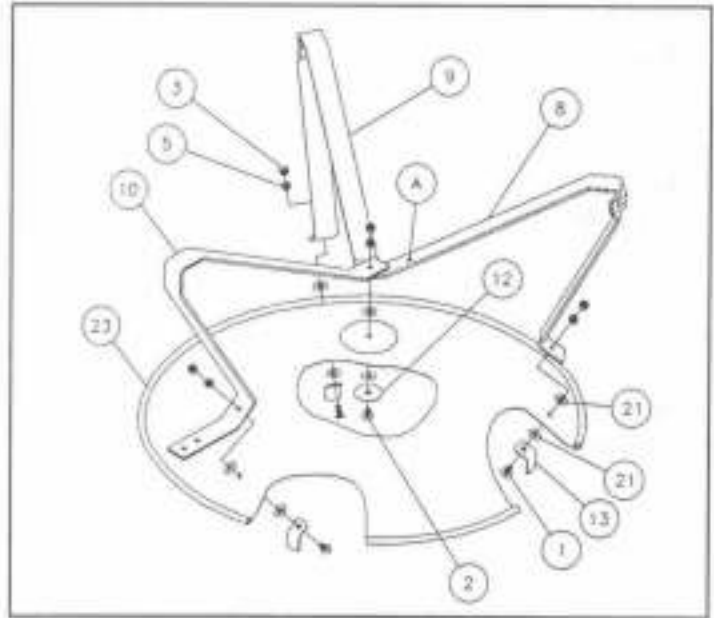

Step 3- Assemble Legs to Bottom- Note! Offsets (bends) on wheel legs(8) & (9) must be parallel. Right wheel leg(8) has a fifth hole (A) whereas left wheel leg(9) has only four for ease of distinction. Assemble right wheel leg(8), left wheel leg(9) and stationary leg(10) to center hole in FirePit bottom bowl(23). Place a 5/16 fender washer(12) onto 5/16 x 1 1/4 bolt(2). Follow this with a 5/16 fiber washer(21). Insert bolt(2) through center hole in FirePit bottom(23) from the inside of bowl and hold in place. Place 5/16 fiber washer(21) on 5/16 x 1 1/4 bolt(2) against porcelain surface. Mount stationary leg(10) onto 5/16 x 1 1/4 bolt(2) and allow weight of leg to hold bolt in place. Mount right wheel leg(8) and left wheel leg(9) onto 1 1/4 bolt(2) in the same manner. Place a 5/16 med lock washer(5) onto 1 1/4 bolt(2) and finish with 5/16 hex nut(3). Finger tighten. From inside of bottom(23) attach ring clip(13) using 5/16 bolt(1) a fiber washer(21) on each side of mounting hole. Slip free end of stationary leg(10) onto bolt(1) and follow with 5/16 med lock washer and 5/16 hex nut(3). Repeat with right wheel leg(8) and left wheel leg(9). Finish tighten at this time. Do not over tighten!

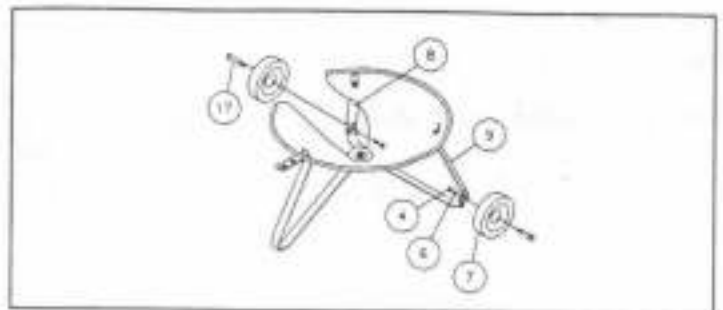

Step 4- Assemble Wheels to Legs- Assemble wheels(7) to wheel legs(8) & (9) using 1/2 x 1 1/2 axle bolts(17), 3/8 lock washers(6) and 3/8 hex nuts(4). Finish tighten. Note- If wheels do not appear parallel, double check position of left and right legs.

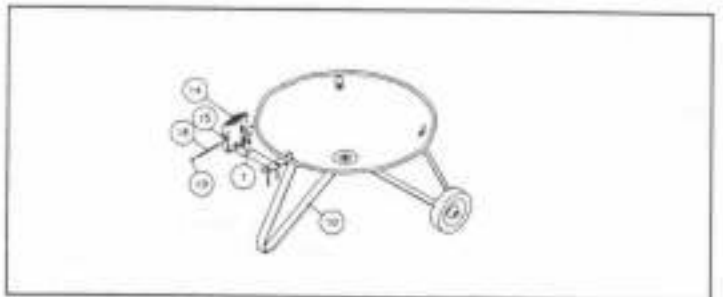

Step 5- Attach Handle to Stationary Leg- Assemble handle(15) to stationary leg(10) using two 5/16 bolts(1), 5/16 lock washers(5) and 5/16 hex nuts(3). Finish tighten.

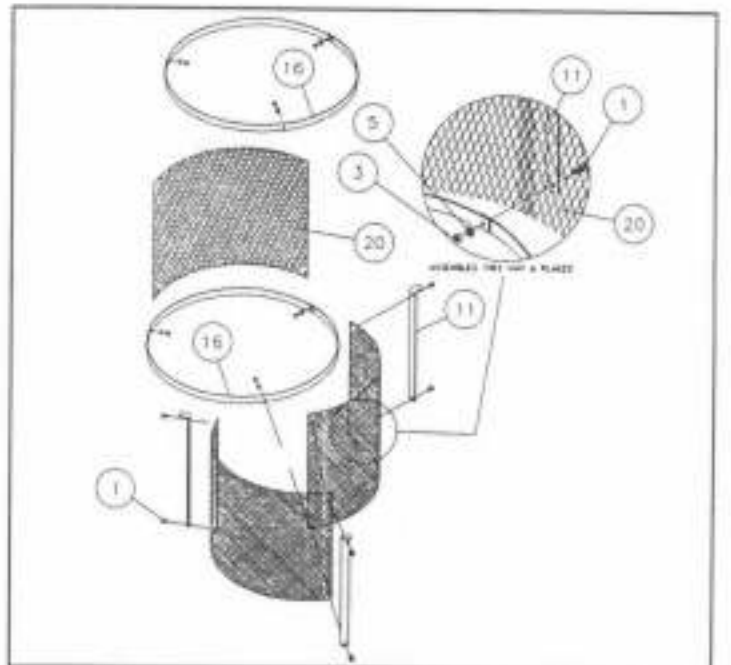

Step 6- Screen Unit Assembly- Begin by temporarily inserting a 5/16 bolt(1) through hole in end of screen ring(16). Overlap with opposite end and push bolt through hole. Loosely secure with 5/16 hex nut(3). Repeat with other screen ring(16). **CAUTION!** Wear work gloves to perform the next steps! Place all three screens(20) over your knee and gently bend downward several times to pre-curve screens. Overlap approximately one inch of two screens(20) so that bolt holes align. Use a 5/16 bolt(1) to go through the top hole in the screen upright(11) just below the angle. Place this bolt through the aligned holes in the overlapped screens(20) and then through a hole in one screen ring(16). Secure with 5/16 lock washer(5) and 5/16 hex nut(3). Finger tighten. Repeat process with second screen upright(11) and finish with third screen upright where screen rings overlap. Remove temporary bolt and insert through screen upright(11), screens(20) and screen ring(16). Install second screen ring at other end of screen uprights by repeating this entire procedure. When all bolts are in place, set bottom of screen unit onto floor and finish tighten.

WHALEN

FirePit • Lawn & Turf

1270 E. Murray

Macomb, Illinois 61455

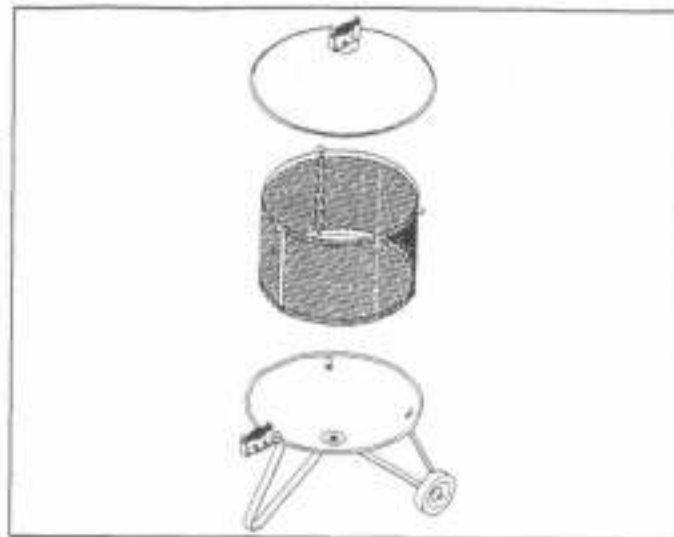

WHALEN

FirePit • Lawn & Turf

1270 E. Murray

Macomb, Illinois 61455

Step 8- Assemble Screen unit, FirePit and Top Cover- Install screen unit on FirePit by placing unit over all three ring clips(13) with short right angle bends to the top. Place FirePit top(22) over screen unit assembly to complete.

IMPORTANT!

BEFORE USING FirePit® FOR THE FIRST TIME, FILL BOTTOM BOWL WITH AT LEAST 25 POUNDS OF CLEAN SAND TO INSULATE BOTTOM AND SUPPORT SURFACE FROM HEAT AND FLAME! SAND SHOULD REMAIN IN PLACE AT ALL TIMES!

!WARNING!

FirePit is for outdoor use only. Keep FirePit away from homes, garages and flammable materials/fluids or vehicles while in use. FirePit is not to be used by children. Be sure screens are in place while in use. Do not use in windy conditions. Use caution when using on combustible surfaces and avoid wearing flammable clothing while FirePit is in use. Always extinguish with lid only and remember ashes can remain hot for long periods. Do not overload or use to burn leaves, trash or paper. Use caution and mitts when handling or moving. When in use, surfaces will be hot. All fires must be completely extinguished before retiring. Do not store hot or with ashes inside. See below for further safety information.

IMPORTANT RULES FOR SAFE OPERATION

- 1 Keep away from flammable material and fluids such as gasoline, alcohol, diesel fuel, kerosene, and charcoal lighter fluid or vehicles while in use.
- 2 Do not use flammable fluids such as gasoline, alcohol, diesel fuel, kerosene or charcoal lighter fluid to light or relight fires.
- 3 Exercise the same precautions you would with an open fire.
- 4 Do not allow children to use the FirePit. Keep children and pets away from the FirePit.
- 5 Do not wear flammable or loose fitting clothing such as nylon when using the FirePit.
- 6 Do not burn trash, leaves, paper cardboard or plywood in the FirePit. Avoid using soft woods such as pine or cedar that are likely to "pop" and throw sparks. Use of seasoned hardwood is suggested.
- 7 Before starting the fire make sure that the lid will still close to extinguish the fire in case of emergency. Do not overload the FirePit to the point that the lid will not close.
- 8 Always extinguish the fire with the FirePit lid. Do not use water to douse the fire as this will fracture the porcelain finish. The FirePit and ashes inside will remain hot for some time. Always leave the lid in place until the FirePit is cold.
- 9 Do not store the FirePit with ashes or combustible materials inside. Do not store the FirePit until the fire is completely out and all surfaces are cold.
- 10 Use fireplace mitts when handling the FirePit and tending the fire. Use long handled, sturdy fireplace equipment when adding or moving logs.
- 11 Do not move the FirePit while in use. If it becomes necessary to move the FirePit remove the screened section and replace the FirePit lid before attempting to move the FirePit.
- 12 Before using the FirePit fill the bottom bowl with approximately 25 pounds of sand to help insulate the bottom and support surfaces from heat.
- 13 Always use in accordance with all applicable local and national fire codes.
- 14 Use only on noncombustible surfaces such as concrete, brick, rock, etc. Do not use on a wooden deck unless screens are in place and FirePit is under constant supervision. Do not leave unattended at any time.
- 15 Keep all bolts, nuts and screws tight to be sure FirePit is in safe working condition. Inspect on a routine basis to ensure that the FirePit is operating reliably.

THANK YOU FOR PURCHASING THIS WHALEN MFG. CO. PRODUCT!

Questions? Comments? Concerns? Please Call 1-800-225-1438