

Pool Breakdown
Trinity 21' Round 52"
NB1821

<p><u>FEATURES:</u> Round Size: 21' Depth: 52" 30 Year Warranty</p>	<p><u>STRUCTURE COMPOSITION:</u> Rugged Steel Frame Resin Top Seat Resin Rail Resin Upright Protective Wall Coatings</p>
--	--

	Qty	Carton #	Carton Content Description
<input type="checkbox"/>	1	2152-MIR-CX-4	TRINITY – 52" INCH VERTICAL UPRIGHT, INSTRUCTIONS, PAPERWORK
<input type="checkbox"/>	1	2152-MIR-CX-2	TRINITY – 7 INCH TOP SEAT
<input type="checkbox"/>	1	21-MRP-CX-3-SW	TRINITY – 7 INCH JOINT, 7 INCH SEAT COVER, 7 INCH SEAT COVER BRACKET, SEAT COVER ASSEMBLY BOLT PACKAGE
<input type="checkbox"/>	1	21-5/8 RAIL-2-RR	TRINITY – 5/8 INCH RESIN RAIL
<input type="checkbox"/>	1	2152-DYN-W-SW	TRINITY – TAUPE WALL, PLASTIC EDGING, 52" WALL JOINT PACKAGE

Carton Breakdown

Trinity 21' Round 52"

NB1821

Key #	Qty	Item #	Mfg Part #	Part Description	
FRAME CARTON # 2152-MIR-CX-4					
<input type="checkbox"/>	1	14	NBP1300	2390	Trinity Vertical (52" High)
<input type="checkbox"/>	---	1	-----	0022	Warranty
<input type="checkbox"/>	---	1	-----	0023	Safety Decals
<input type="checkbox"/>	---	1	-----	0024	Parts List + Frame Instruction
<input type="checkbox"/>	---	1	-----	0001	Round Instruction Manual
FRAME CARTON # 2152-MIR-CX-2					
<input type="checkbox"/>	7	14	NBP1301	1105	Trinity Top Seat L=1444mm (56-7/8") 15ft
FRAME CARTON # 21-MRP-CX-3-SW					
<input type="checkbox"/>	5	14	NBP1061	2176	7in Resin Joint - Upper
<input type="checkbox"/>	6	14	NBP1062	2276	7in Resin Joint - Lower
<input type="checkbox"/>	2	14	NBP1302	2485	Trinity Seat Cover
<input type="checkbox"/>	3	14	NBP1303	2486	Trinity Seat Cover Bracket
Seat Cover Assembly Bolt Package (Part # 0341, Order # NBP1111)					
<input type="checkbox"/>	9	182	NBP1111	0341*	#12 Sheet Metal Screw
<input type="checkbox"/>	4	14	NBP1111	2402*	Seat Cover Cap
FRAME CARTON # 21-5/8 RAIL-2-RR					
<input type="checkbox"/>	8	28	NBP1306	1721-R	5/8in Resin Rail L=1431mm (56-3/8")
WALL CARTON # 2152-DYN-W-SW					
<input type="checkbox"/>	10	1	PC5410	52" Wall	Taupe Wall
<input type="checkbox"/>	11	16	NL107	8100	Plastic Edging
52" Wall Joint Bolt Package (Part # 0113, Order # NBP1021)					
<input type="checkbox"/>	---	26	NBP1021	0513*	1/4" x 1/2" Truss Head Screw
<input type="checkbox"/>	---	51	NBP1021	0411*	1/4" Reinforcing Washer
<input type="checkbox"/>	---	26	NBP1021	0611*	1/4" Nut

*These part #'s are not available to purchase separately. They must be purchased as the Seat Cover Assembly Bolt Package, Order # NBP1111 or Wall Joint Bolt Package, Order # NBP1021.

Trinity 21' Round 52"

NB1821

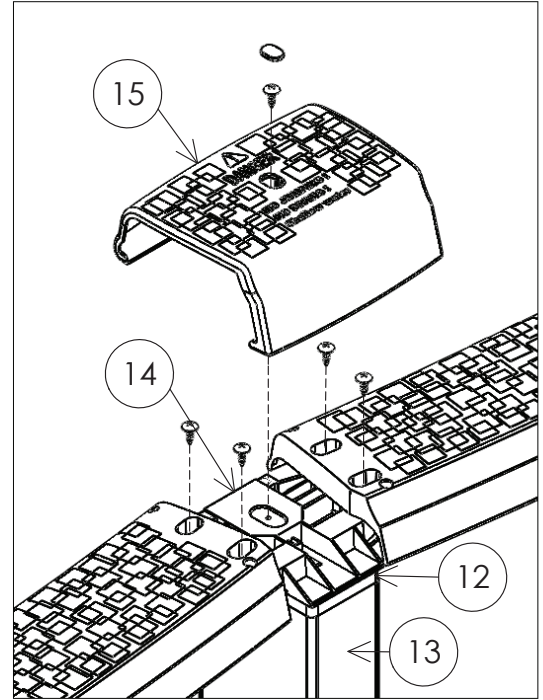
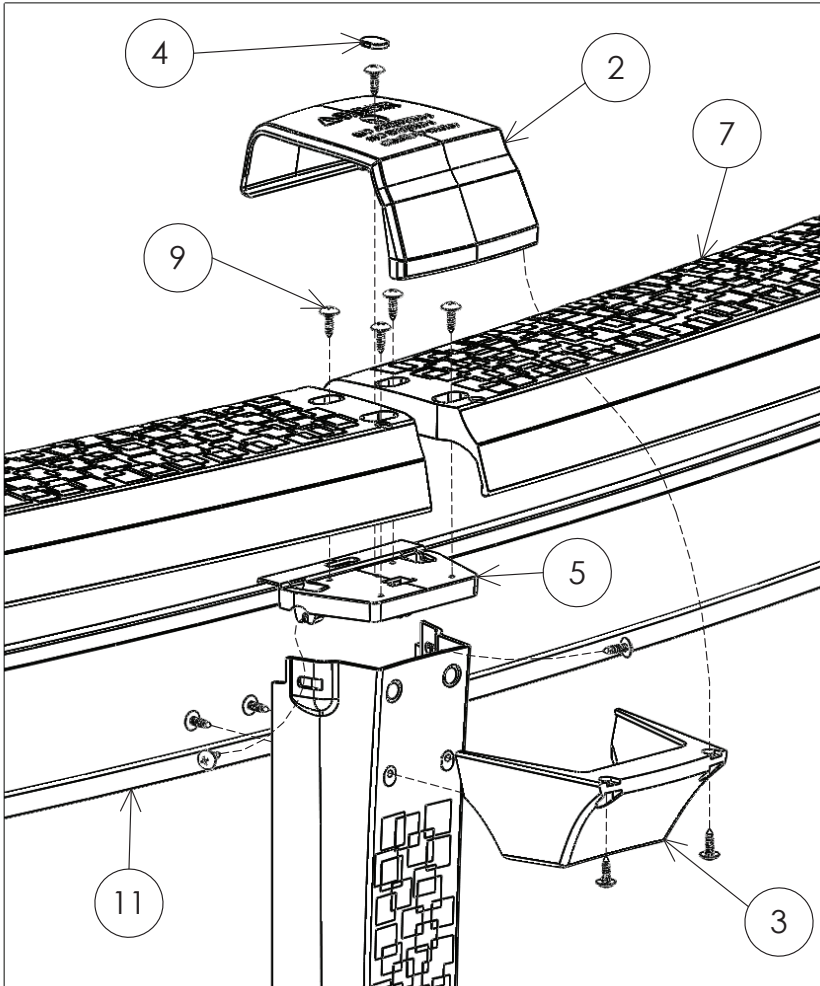

For Oval Pool Only

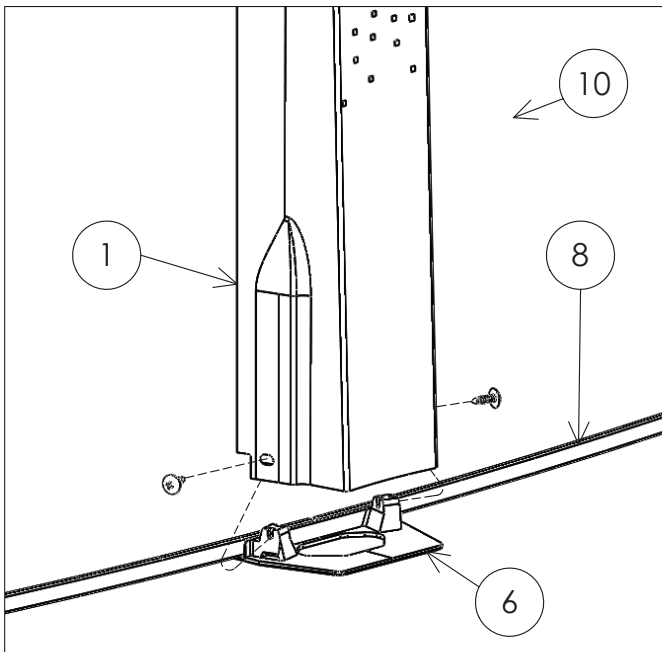

Parts List		
Key #	Description	Item #
1	Trinity Vertical 52in	NBP1300
2	Trinity Seat Cover	NBP1302
3	Trinity Seat Cover Bracket	NBP1303
4	Seat Cover Cap	NBP1111
5	7" Resin Upper Joint	NBP1061
6	7" Resin Lower Joint	NBP1062
7	Trinity Radius Top Seat	NBP1301
8	5/8" Rail	NBP1306
9	#12 Sheet Metal Screw	NBP1111
10	Taupe Wall	PC5410
11	Plastic Edging	NL107
12	Side Vertical for BL	-----
13	Side Vertical Skin	-----
14	Resin Side Upper Joint	-----
15	Trinity Side Seat Cover	-----