

STEEL WALL POOL SYSTEM

16'-5" x 28'-4" FREEFORM

DWG #: GS-11086-DB	DATE: 1/15/2020	REV: -	PAGE 1 OF 4
AREA (SqFt): 359	PERIMETER: 74.5	EST. VOL (US Gal): TBD	

1628 FREEFORM ONGROUND KIT

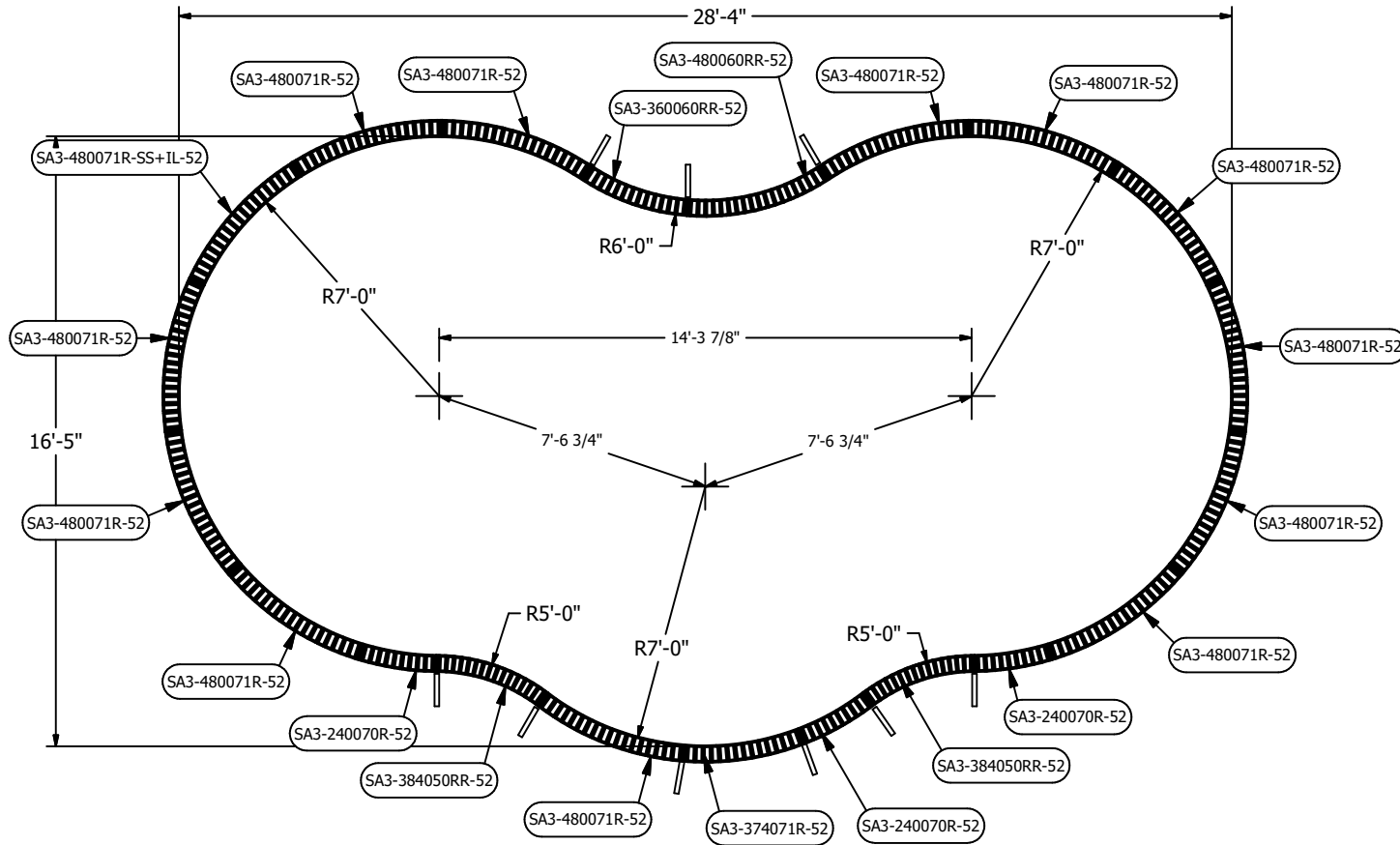

RADIUS STEP OPTION
SEE INSTALL GUIDE FOR
INSTALLTION

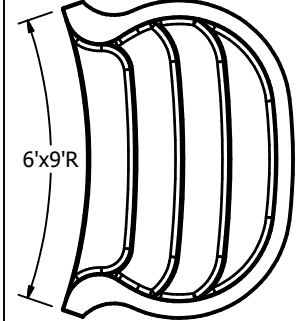

- K1FS-1628R6B - BLUE
- K1FS-1628R6G - GREY
- K1FS-1628R6W - WHITE

MATERIALS		
QTY	PART #	DESCRIPTION
3	SA3-240070R-52	Stl Pnl 24" x 7'R (52" Tall)
1	SA3-360060RR-52	Stl Pnl 36" x 6'R Reverse (52" Tall)
1	SA3-374071R-52	Stl Pnl 37 1/2" x 7'R - 1 Rib (52" Tall)
2	SA3-384050RR-52	Stl Pnl 38 1/2" x 5'R Reverse (52" Tall)
1	SA3-480061RR-52	Stl Pnl 48" x 6'R Reverse (52" Tall) - 1 Rib
12	SA3-480071R-52	Stl Pnl 48" x 7'R (52" Tall) - 1 Rib
1	SA3-4801DS+IL-52	Stl Pnl 48" DB Skim+Inlet Lft (52" Tall)-1 Rib

BRACE / HARDWARE OPTIONS		
QTY	PART NUMBER	DESCRIPTION
9	SA3-BTBRC-Z	Stl Brc Buttress Brace + Stake
1	HW-2002	Hdw Steel/Rrd Kit
2	HW-2013	Hdw Steel Add-on Kit (3/8" Bolts-100, 3/8" Nuts-100)

COPING		
QTY	PART #	DESCRIPTION
1	HW-2019	Hdw On Ground No-Diving Kit (14/bag) *Mandatory Safety Signage*
1	HW-1007	Hdw 12x1" Tek Screws - 100/Box
10	ATFC-9601FRG	Alu Txt 8' F-Channel - Radius Grey - 1/Box

NO DIVING DANGER: DIVING MAY RESULT IN SERIOUS INJURY OR DEATH. Signage must be permanently attached around the perimeter of the pool.

THIS DOCUMENT IS FOR ILLUSTRATIVE PURPOSES ONLY.

Original Equipment Manufacturer makes only those representations which are stated in its written warranty. Any other representations, statements, or contracts made by the dealer/contractor to the customer regarding any components produced by Original Equipment Manufacturer are attributable to the dealer/contractor only. The dealer or contractor who sells or installs your pool is an independent contractor and is not an agent or employee of Original Equipment Manufacturer. The construction methods illustrated here are suggestions and apply only to normal ground conditions. There may be additional precautions and/or methods of construction. The responsibility is the contractor's. -A safety line, with buoys, is to be permanently attached 1'-0" to the shallow side of the point of first slope change. -Different methods and precautions may be dictated by various ground conditions. This is to be determined by and is the responsibility of the contractor who is not an agent of the manufacturer of the component parts. -Installation is to be done in accordance with all federal, state and local building codes, as well as A.N.S.I./N.S.P.I. suggested standards. -BOTTOM SPECIFICATIONS MUST MEET OR EXCEED A.N.S.I./N.S.P.I./A.P.S.P. RECOMMENDED STANDARDS -"NO DIVING" signage must be permanently attached to the entire perimeter of the pool. See instructions with signage. -IT IS RECOMMENDED TO NOT INSTALL DIVING BOARDS AND/OR SLIDING EQUIPMENT ON RESIDENTIAL POOLS. If diving boards and/or sliding equipment is installed by the contractor, such diving boards and sliding equipment MUST BE INSTALLED WITHIN THE GUIDELINES ESTABLISHED BY ANSI/NSPI/ASPA RECOMMENDED STANDARDS, AND IN ACCORDANCE WITH ALL APPLICABLE STATE AND LOCAL CODES AND REGULATIONS.



STEEL WALL POOL SYSTEM

16'-5" x 28'-4" FREEFORM

DWG #: GS-11086-DB	DATE: 1/15/2020	REV: -	PAGE 2 OF 4
AREA (SqFt): 359	PERIMETER: 74.5	EST. VOL (US Gal): TBD	

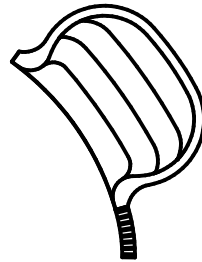

K1FS-1628F6RB - BLUE
 K1FS-1628F6RG - GREY
 K1FS-1628F6RW - WHITE
 (KIT CONTAINS x1 SA3F-2300R-52 PANEL WHICH CAN BE USED IN COMBINATION TO ACCOMATED 6'R STEP)

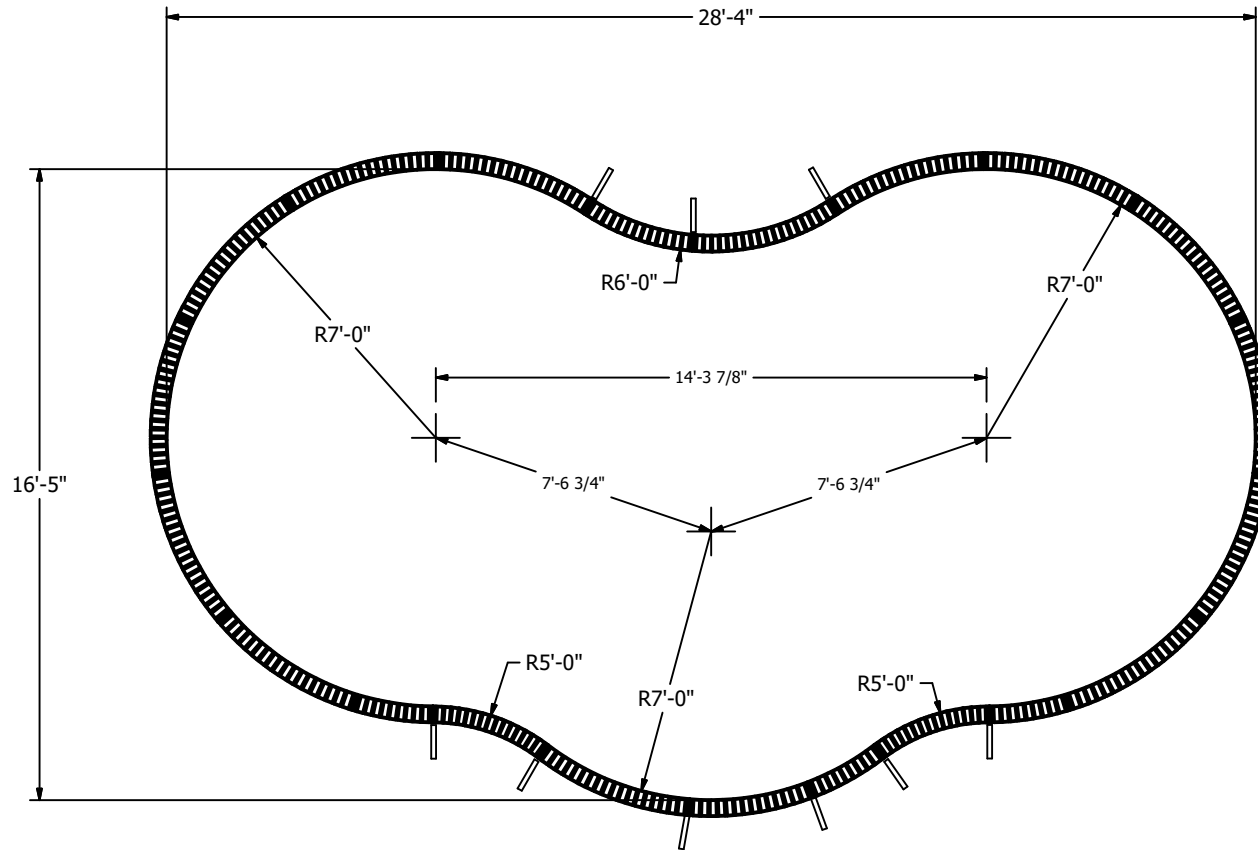

OPTION
 (REPLACE x2 48" RADIUS
 PANEL ON ANY SIDE)

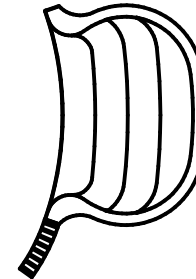

SA3-BTBRC-Z
 (SIDE PROFILE)

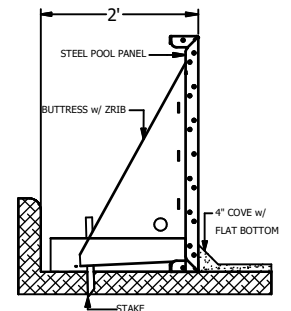

NO DIVING DANGER: DIVING MAY RESULT IN SERIOUS INJURY OR DEATH. Signage must be permanently attached around the perimeter of the pool.

THIS DOCUMENT IS FOR ILLUSTRATIVE PURPOSES ONLY.

Original Equipment Manufacturer makes only those representations which are stated in its written warranty. Any other representations, statements, or contracts made by the dealer/contractor to the customer regarding any components produced by Original Equipment Manufacturer are attributable to the dealer/contractor only. The dealer or contractor who sells or installs your pool is an independent contractor and is not an agent or employee of Original Equipment Manufacturer. The construction methods illustrated here are suggestions and apply only to normal ground conditions. There may be additional precautions and/or methods of construction. The responsibility is the contractor's. -A safety line, with buoys, is to be permanently attached 1'-0" to the shallow side of the point of first slope change. -Different methods and precautions may be dictated by various ground conditions. This is to be determined by and is the responsibility of the contractor who is not an agent of the manufacturer of the component parts. -Installation is to be done in accordance with all federal, state and local building codes, as well as A.N.S.I./N.S.P.I. suggested standards. -BOTTOM SPECIFICATIONS MUST MEET OR EXCEED A.N.S.I./N.S.P.I./A.P.S.P. RECOMMENDED STANDARDS. -"NO DIVING" signage must be permanently attached to the entire perimeter of the pool. See instructions with signage. -IT IS RECOMMENDED TO NOT INSTALL DIVING BOARDS AND/OR SLIDING EQUIPMENT ON RESIDENTIAL POOLS. If diving boards and/or sliding equipment is installed by the contractor, such diving boards and sliding equipment MUST BE INSTALLED WITHIN THE GUIDELINES ESTABLISHED BY ANSI/NSPI/ASPA RECOMMENDED STANDARDS, AND IN ACCORDANCE WITH ALL APPLICABLE STATE AND LOCAL CODES AND REGULATIONS.



STEEL WALL POOL SYSTEM

16'-5" x 28'-4" FREEFORM

DWG #: GS-11086-DB DATE: 1/15/2020 REV: - PAGE 4 OF 4

AREA (SqFt): 359 PERIMETER: 74.5 EST. VOL (US Gal): TBD

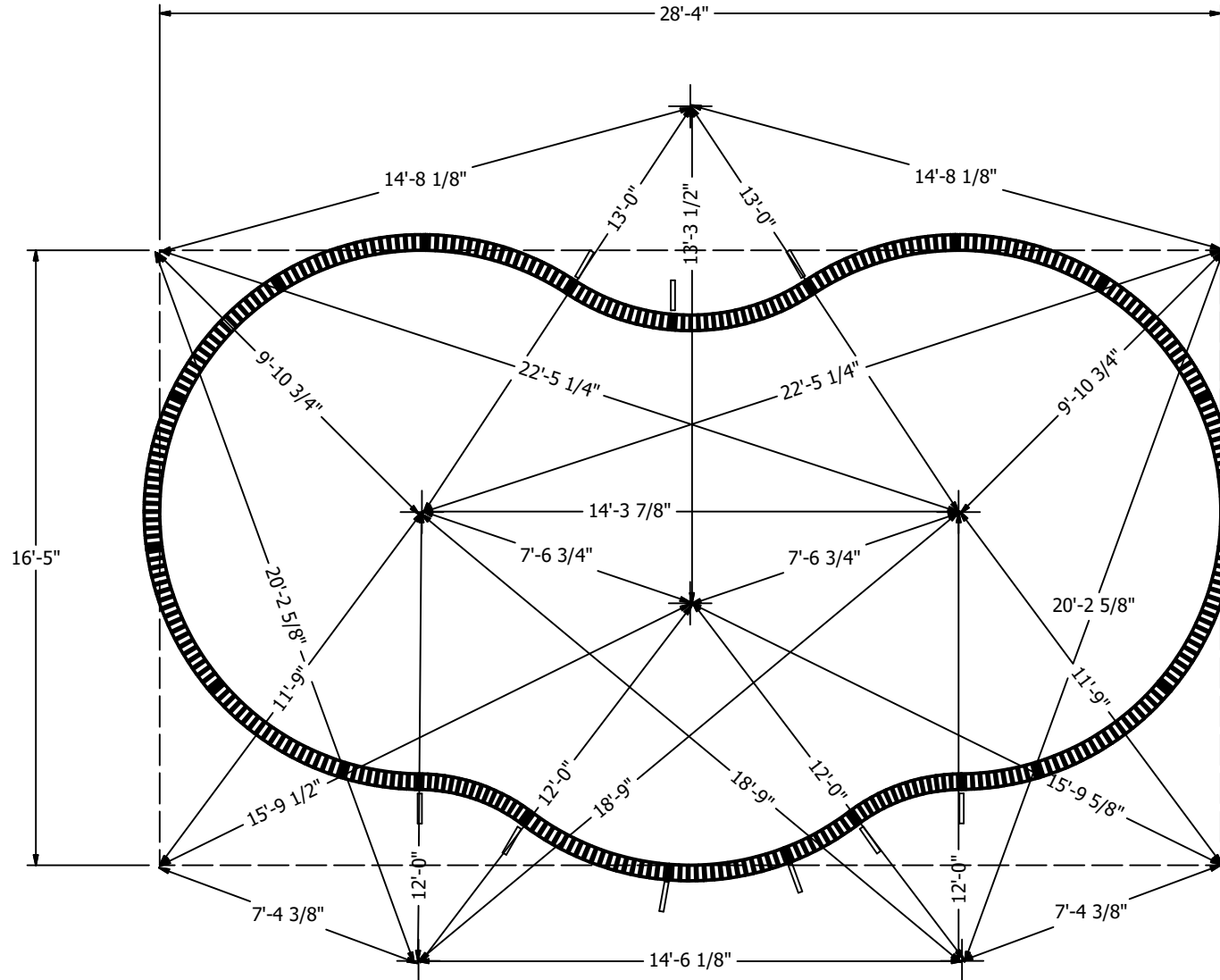

NO DIVING DANGER: DIVING MAY RESULT IN SERIOUS INJURY OR DEATH. Signage must be permanently attached around the perimeter of the pool.

THIS DOCUMENT IS FOR ILLUSTRATIVE PURPOSES ONLY. Original Equipment Manufacturer makes only those representations which are stated in its written warranty. Any other representations, statements, or contracts made by the dealer/contractor to the customer regarding any components produced by Original Equipment Manufacturer are attributable to the dealer/contractor only. The dealer or contractor who sells or installs your pool is an independent contractor and is not an agent or employee of Original Equipment Manufacturer. The construction methods illustrated here are suggestions and apply only to normal ground conditions. There may be additional precautions and/or methods of construction. The responsibility is the contractor's. -A safety line, with buoys, is to be permanently attached 1'-0" to the shallow side of the point of first slope change. -Different methods and precautions may be dictated by various ground conditions. This is to be determined by and is the responsibility of the contractor who is not an agent of the manufacturer of the component parts. -Installation is to be done in accordance with all federal, state and local building codes, as well as A.N.S.I./N.S.P.I. suggested standards. -BOTTOM SPECIFICATIONS MUST MEET OR EXCEED A.N.S.I./N.S.P.I./A.P.S.P. RECOMMENDED STANDARDS -"NO DIVING" signage must be permanently attached to the entire perimeter of the pool. See instructions with signage. -IT IS RECOMMENDED TO NOT INSTALL DIVING BOARDS AND/OR SLIDING EQUIPMENT ON RESIDENTIAL POOLS. If diving boards and/or sliding equipment is installed by the contractor, such diving boards and sliding equipment MUST BE INSTALLED WITHIN THE GUIDELINES ESTABLISHED BY ANSI/NSPI/ASPA RECOMMENDED STANDARDS, AND IN ACCORDANCE WITH ALL APPLICABLE STATE AND LOCAL CODES AND REGULATIONS.

