

SEASIDE

48" Tall Round Pools

Parts List

SEASIDE — Pool Parts List

ITEM	DESCRIPTION	12'		15'		18'		24'		PART #	QTY.
		PART #	QTY.	PART #	QTY.	PART #	QTY.	PART #	QTY.		
	FRAME PACK	5-1248-492	1	5-1548-492	1	5-1848-492	1	5-2448-492	1		
1.	Plastic Coping, 24"	545-1001	21	545-1001	24	545-1001	31	545-1001	40		
2.	Vertical End Cap	580-1961	10	580-1961	10	580-1961	12	580-1961	16		
3.	Stabilizer Rail, large dia.	583-1011	6	583-1011	8	583-1011	9	583-1005	11		
4.	Stabilizer Rail, small dia.	583-1012	6	583-1012	8	583-1012	9	583-1004	11		
5.	Bottom Rail	589-1133	10	589-1302	10	589-1299	12	589-1222	16		
6.	Bottom Connector	580-1920	10	580-1920	10	580-1920	12	580-1920	16		
7.	Top Connector	340-2139	10	340-2139	10	340-2139	12	340-2139	16		
*8.	Sheet Metal Screw, #10 x 1/2"	330-1127	70	330-1127	70	330-1127	84	330-1127	112		
9.	Pool Parts List	573-3704	1	573-3704	1	573-3704	1	573-3704	1		
10.	Pool Installation Instructions	573-3705	1	573-3705	1	573-3705	1	573-3705	1		
11.	Warranty Card	—	1	—	1	—	1	—	1		
12.	"Safety First" Booklet	573-3169	1	573-3169	1	573-3169	1	573-3169	1		
13.	Vertical	580-2374	10	580-2374	10	580-2374	12	580-2374	16		
14.	—	—	—	—	—	—	—	—	—		
15.	—	—	—	—	—	—	—	—	—		
16.	—	—	—	—	—	—	—	—	—		
17.	—	—	—	—	—	—	—	—	—		
18.	Top Rail	587-1350	10	587-1351	10	587-1351	12	587-1351	16		
19.	—	—	—	—	—	—	—	—	—		
	SIDEWALL CARTON										
20.	Sidewall		1		1		1		1		
21.	Protective strip	535-1442	1	535-1442	1	535-1442	1	535-1442	1		
22.	1/4-20 Hex flange locknut	321-1029	26	321-1029	26	321-1029	26	321-1029	26		
23.	1/4-20 x 1/2" grade 5 Ph. screw	330-1280	26	330-1280	26	330-1280	26	330-1280	26		
24.	"Safety First" booklet	573-3169	1	573-3169	1	573-3169	1	573-3169	1		
25.	Safety video	573-3498	1	573-3498	1	573-3498	1	573-3498	1		
26.	Warning sign decal	560-1055	1	560-1055	1	560-1055	1	560-1055	1		

* Screws are available in most hardware stores.

** Write sidewall carton number here and above _____.

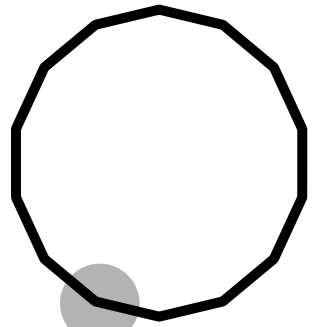

END VIEW

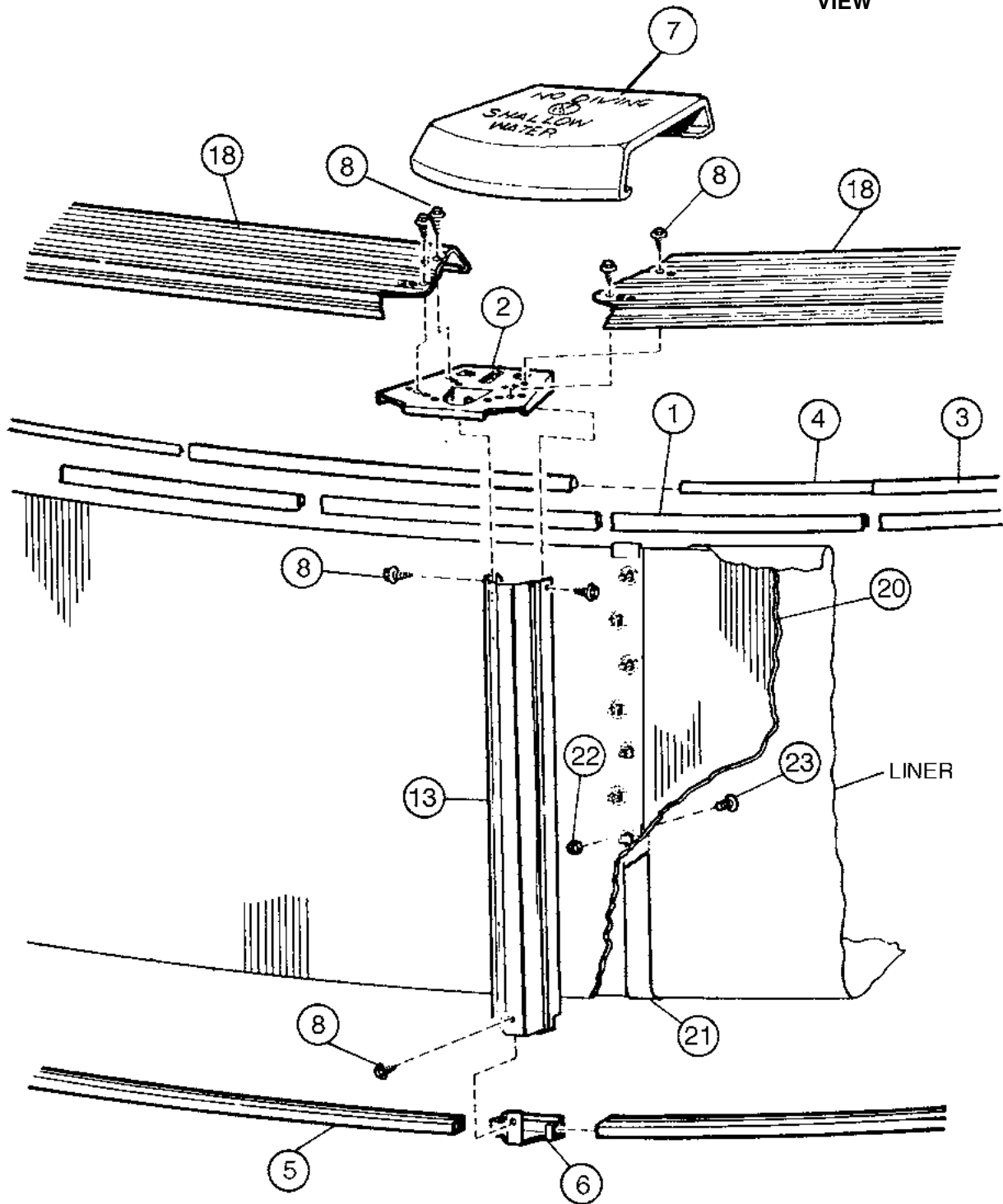



Important! Above-ground pools are designed for swimming and wading only. Do not Dive or Jump! Misuse of your pool may result in crippling injury and/or other dangers to life and health. Do not use slides, diving boards, or any other platform or object which can be used for improper pool entry. Use only an above-ground swimming pool ladder to enter or exit your pool. It is the pool owner's responsibility to secure the pool against unauthorized, unsupervised or unintentional entry. It is also the pool owner's responsibility to warn all pool users of the hazards of diving into shallow water: paralyzing injury may result. Always obey all safety rules. Remember, pool safety is everybody's responsibility.

Change of Design: The manufacturer (HII) expressly reserves the right to change or modify the design and construction of any product in due course of our manufacturing procedures, without incurring any obligation or liability to furnish or install such changes or modifications on products previously or subsequently sold.